



Leaf







G-60070-C-A-CA-U-5



Grass

G-60070-B-A-PA-T-5

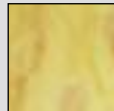
Lens Options

ICE Code: A	GRASS Code: B*	LEAF Code: C	WEAVE Code: D*	FAUX ALABASTER Code: F	EARTH MARBLE Code: M	FIRE Code: I
						

Codes A Through D - Cast Resin
 Codes F & M - Acrylic
 Code I - Art Glass

Fixtures can be modified to include a flat artglass panel of your choice with or without a protective clear polycarbonate lens. Other cast resin lens options available to coordinate with your current application. Contact factory for details or other modifications.

***Not recommended for diamond mounting**

Please note that by their nature, these panels will vary.

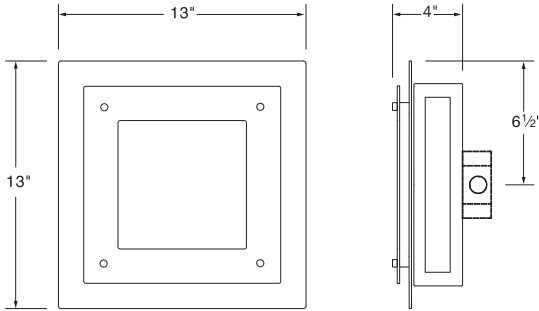

G-60070

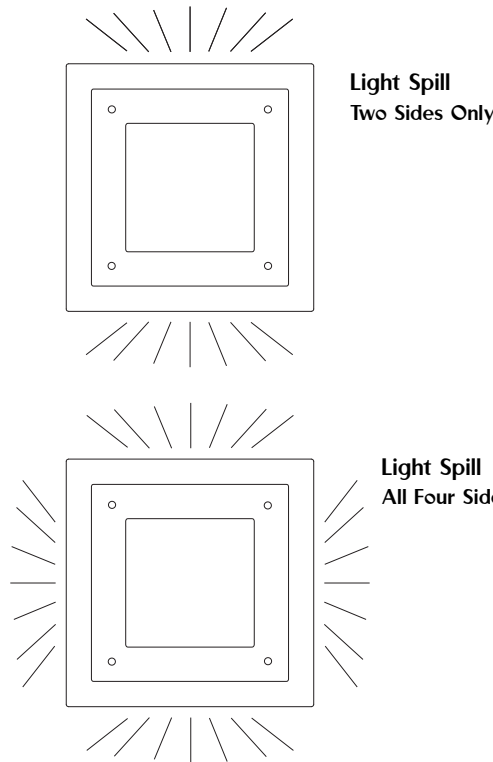

Lens Options

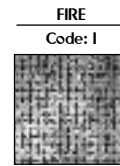
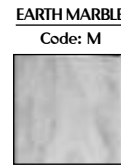
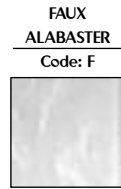
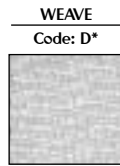
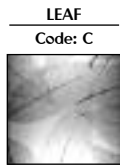
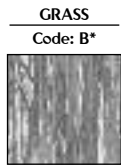

Codes A Through D - Cast Resin
 Codes F & M - Acrylic
 Code I - Art Glass

***Not recommended for diamond mounting**

Please note that by their nature, these panels will vary.

Lamping

- A 2 CFQ-26 G24q-3 4 pin Universal Voltage
- B 1 2D 38W GR10q-4 4 pin
- C 2 T-10 40W Medium Base 120V

Please state voltage. See Code. Code: 1 120 volts
 2 277 volts

Options

- 1 Emergency Ballast remotely mounted
- 2 Gel (must specify Roscolux™ color)
- 3 Round Perf
- 4 Square Perf
- 5 No options needed

Finishes

First position select front finish and second position select back box finish.

Standard Painted Finishes		Code	
Satin Black	A	Light Bronze	G
Reflector White	B	Dark Bronze	H
Painted Aluminum	C	Painted Antique Brass	I
New Satin Nickel	D	Gray Granite	J
Faux Rust	E	Light Verdigris	K
Beige	F	Sungold	L

Standard Metallic Finishes

Brushed Aluminum P

(Back box only available in painted finish.)

How To Specify

To specify a Fire ADA Wall Sconce without Perf, with Brushed Aluminum Front and Painted Black back box, 2D lamp, 277V, light spill on two sides and Remote Emergency Ballast:

G-60070-I-B2-PA-T-1

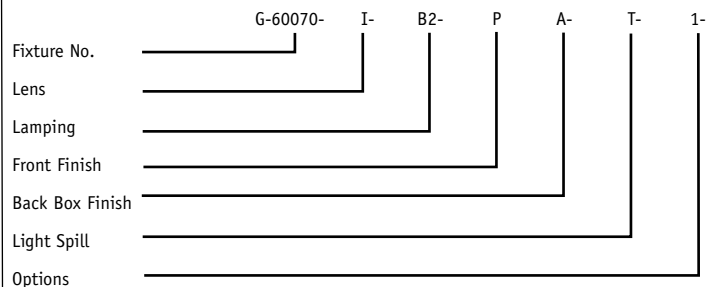

(Contact your local G Lighting Representative for assistance.)

Light Spill Onto Wall

- T Two Sides only
- U All four sides